

GRP Grating

Our GRP Grating is a specially designed and moulded non-slip composite floor solution, constructed from the highest quality fibreglass making it lightweight and also chemical, rust, and corrosion resistant whilst offering longevity and durability. With limited tooling and installation costs, we can offer a vast range of standard length and width sizes, plus our in-house cutting service means we can offer bespoke sizes for that perfect fit.

Available in 25mm, 38mm and 50mm thickness and an array of colours.

Optional clips or clamps are available to purchase if required.

Features

- ◆ **Typical applications:** Perfect solution for platforms, walkways, flooring, ramps and covers for industrial or construction sites, chemical and shipping industries, water treatment plants as well as offshore oil rigs.
- ◆ **Material:** GRP - Glass reinforced polyester with a resin coated gritted surface.
- ◆ **Cleaning:** Use of a stiff brush will normally be sufficient to remove everyday dirt and debris, and for more stubborn dirt a mild detergent with warm water is often effective. A pressure washer on a low pressure setting can be used to clean the GRP.
- ◆ **Sustainability:** REACH compliant.
- ◆ **Warranty:** Lifetime.

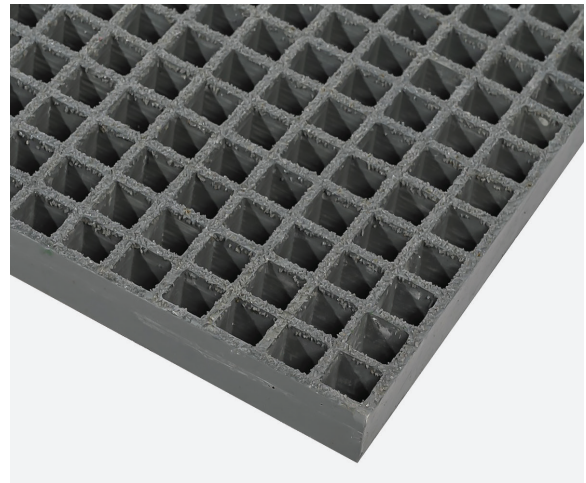

Suitable for indoor and outdoor use

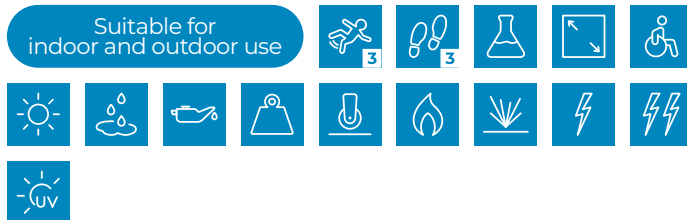
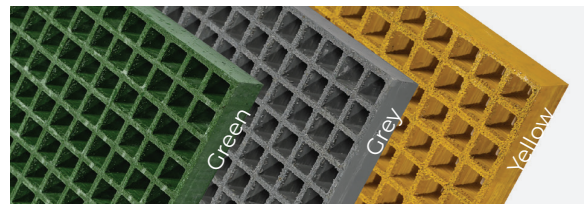
For more information about this product or, to place an order [click here](#)

Code	Size	Thickness	Weight	Colour
GR3939-25GN	996mm x 996mm	25mm	12.5kg	Green
GR3939-25GY	996mm x 996mm	25mm	12.5kg	Grey
GR3939-25YL	996mm x 996mm	25mm	12.5kg	Yellow
GR3960-25GN	1492mm x 996mm	25mm	18kg	Green
GR3960-25GY	1492mm x 996mm	25mm	18kg	Grey
GR3960-25YL	1492mm x 996mm	25mm	18kg	Yellow

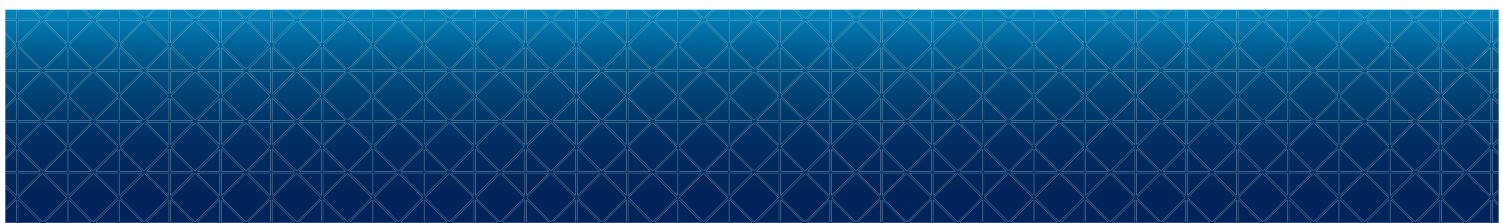

GRP Grating

Code	Size	Thickness	Weight	Colour
GR3979-25GN	1985mm x 996mm	25mm	25kg	Green
GR3979-25GY	1985mm x 996mm	25mm	25kg	Grey
GR3979-25YL	1985mm x 996mm	25mm	25kg	Yellow
GR3910-25GN	3010mm x 996mm	25mm	37kg	Green
GR3910-25GY	3010mm x 996mm	25mm	37kg	Grey
GR3910-25YL	3010mm x 996mm	25mm	37kg	Yellow
GR4812-25GN	3660mm x 1220mm	25mm	55kg	Green
GR4812-25GY	3660mm x 1220mm	25mm	55kg	Grey
GR4812-25YL	3660mm x 1220mm	25mm	55kg	Yellow
GR3939-38GN	996mm x 996mm	38mm	38kg	Green
GR3939-38GY	996mm x 996mm	38mm	38kg	Grey
GR3939-38YL	996mm x 996mm	38mm	38kg	Yellow
GR3960-38GN	1492mm x 996mm	38mm	29kg	Green
GR3960-38GY	1492mm x 996mm	38mm	29kg	Grey
GR3960-38YL	1492mm x 996mm	38mm	29kg	Yellow
GR3979-38GN	1985mm x 996mm	38mm	40kg	Green
GR3979-38GY	1985mm x 996mm	38mm	40kg	Grey
GR3979-38YL	1985mm x 996mm	38mm	40kg	Yellow
GR3910-38GN	3010mm x 996mm	38mm	58.5kg	Green
GR3910-38GY	3010mm x 996mm	38mm	58.5kg	Grey
GR3910-38YL	3010mm x 996mm	38mm	58.5kg	Yellow
GR4812-38GN	3660mm x 1220mm	38mm	87kg	Green
GR4812-38GY	3660mm x 1220mm	38mm	87kg	Grey
GR4812-38YL	3660mm x 1220mm	38mm	87kg	Yellow
GR4812-50GN	3665mm x 1225mm	50mm	115kg	Green
GR4812-50GY	3665mm x 1225mm	50mm	115kg	Grey
GR4812-50YL	3665mm x 1225mm	50mm	115kg	Yellow

GRP Grating

Code	Size	Thickness	Weight	Colour
CC-25SS	C Clip for 25mm Grating c/w fixing bolt		0.04kg	Stainless Steel
CC-38SS	C Clip for 38mm Grating c/w fixing bolt		0.06kg	Stainless Steel
CC-50SS	C Clip for 50mm Grating c/w fixing bolt		0.07kg	Stainless Steel
MC-25SS	M Clip for 25mm Grating		0.03kg	Stainless Steel
MC-38SS	M Clip for 38mm Grating		0.04kg	Stainless Steel
MC-50SS	M Clip for 50mm Grating		0.05kg	Stainless Steel
JC-38SS	J Clamp		0.07kg	Stainless Steel
FC45SS	Square Fixing Clip 45mm		0.02kg	Stainless Steel
FD4555	Fixing Disc 45mm		0.1kg	Stainless Steel
M8-35SS	M8 x 34mm Bolt/Nut/Washer Set		0.03kg	Stainless Steel

Please note, cutting tolerance +/- 5mm

Technical Specification

Slip resistant:	Excellent slip resistance to level 3
Wear resistant:	Excellent wear resistance to level 3, suitable for heavy footfall
Chemical resistant:	Yes
Cut to size:	Yes, tolerance +/- 5mm
Disability friendly:	Yes, the low profile makes it suitable for wheelchair users
Dry area:	Yes
Wet area:	Yes
Oily and greasy area:	Yes
Heavy area:	Yes
Wheeled area:	Yes
Environment:	Suitable for indoor and outdoor use
Flame retardant:	Yes
Impact resistant:	Yes
Non-conductive (Electrical):	Yes

GRP Grating

Technical Specification

Non-conductive (HV Electrical): Yes

- Product testing:
- ◆ Slip resistance
 - ◆ Tested to BS 7976.2 - PTV 'Extremely Low' for wet and dry conditions, PTV 'Low' for oily and greasy conditions
 - ◆ Coefficient of Friction (CoF): Dry 72; Wet 68 and Oil 63
 - ◆ Fire certificate
 - ◆ Standard ISO Resin - BS 476 Part 7 Class 2
 - ◆ ASTM-E84 Flame Spread 25, Smoke Density 325
 - ◆ Load certificate
 - ◆ BS EN 124 – Class A15
 - ◆ UV certificate
 - ◆ UV Weather ISO 4892-2 Xenon Arc 5000hrs

Sustainability: REACH (Registration, Evaluation, Authorisation and Restrictions of Chemicals)

Temperature resistance: -50°C to +110°C

UV Resistant: Yes



GRP Grating

* The differences between Class 1 and Class 2

Both are classifications of the surface spread of flame test (BS 476 part 7). They refer to the degree of flame spread on an ignited panel 900mm x 230mm cut from a laminate. The panel is exposed at right angles to a radiant panel to reproduce the effect of a fire on an adjoining wall or ceiling. It is ignited at the hotter end and allowed to burn for 10 minutes. Flame spread is measured along a line 75mm from the base.

- ◆ Class 1 rating is given if the spread of flame is no greater than 165mm.
- ◆ Class 2 rating is given if the spread of flame is no greater than 215mm in the first 1½ minutes and on overall spread of no more than 455mm.
- ◆ Class 0 rating is a Building Regulations rating and not a British Standard Classification. To attain Class 0, a sample must meet Class 1 for spread of flame and also meet the fire propagation requirements of BS476 Part 6.
- ◆ The Part 6 test was introduced because investigations into the growth of building fires showed that spread of flame was not the only significant factor. Fire propagation (or the amount of heat added to a fire by the energy output of burning materials) was also an important consideration.

Pendulum Slip Testing

The pendulum slip testing was carried out on 17.02.23 and concluded that our GRP Grating achieved the highest slip resistant classification of 'Extremely Low' pedestrian slip risk for wet and dry conditions and 'Low' for oily/greasy areas.

Pendulum Test Value (PTV)	Slip Risk
0 - 24	High
25 - 35	Moderate
36 - 64	Low
65+	Extremely Low

Pendulum test results	Coefficient of Friction (CoF)		
	Dry	Wet	Oil
Standard Grit	72	68	63



GRP Grating

GRP Care and Maintenance

◆ Cleaning

Being a highly durable material, using a stiff brush will normally be sufficient to remove everyday dirt and debris, and for more stubborn dirt, wash with warm water and a mild detergent. A pressure washer on a low-pressure setting can also be used, however, care should be taken to ensure that this does not harm the integrity of the fixings being used, likely to be screws and/or adhesive.

We recommend always testing any cleaning method and liquids on a small inconspicuous section before applying to the full area. Any spills should be cleaned immediately in line with the product data sheets and the company's own safety procedures.

◆ General Routine Maintenance

The integrity of all fixings should be checked on a regular basis to ensure that the grating remain in a firm and stable position. The gritted surfaces and GRP substrate should also be checked regularly, the frequency would depend on the nature and volume of footfall. As a guide, for high traffic areas a monthly inspection would be advisable.

◆ Life expectancy

Our GRP Grating have a design life of 10+ years, however, the life expectancy of any flooring product will be dictated by the nature and volume of the traffic it receives. Factors such as footwear type and material, weight of individual, pedestrian or non-pedestrian traffic, and any contamination such as dirt or grit are all factors that will influence the life term through natural wear and tear of the GRP.

Installation

◆ Handling

Safe handling practices should always be employed. GRP should also be stored face down to prevent damage.

◆ Cutting

Minor adjustments, small cut outs, can be made with a hacksaw or a jigsaw with a suitable blade. We offer a full in-house cutting service, however, should you wish to cut the grating yourself, this is easily to do by using orbital cutting equipment with either a stone or diamond blade. Cutting should be carried out externally, or where there is dust extraction, or suitable ventilation. Appropriate protective equipment should always be worn.

We're here to help

Should you have any questions about our GRP Grating, or need advice regarding care, maintenance or installation, we're only a phone call away.



GRP Grating

Closed Edge Sizes

32mm x 32mm internal, applicable to both 25mm and 38mm grating.

44.1mm	653.7mm	1263.3mm	1872.9mm	2482.5mm	3092.1mm
82.2mm	691.8mm	1301.4mm	1911.0mm	2520.6mm	3130.2mm
120.3mm	729.9mm	1339.5mm	1949.1mm	2558.7mm	3168.3mm
158.4mm	768.0mm	1377.6mm	1987.2mm	2596.8mm	3206.4mm
196.5mm	806.1mm	1415.7mm	2025.3mm	2634.9mm	3244.5mm
234.6mm	844.2mm	1453.8mm	2063.4mm	2673.0mm	3282.6mm
272.7mm	882.3mm	1491.9mm	2101.5mm	2711.1mm	3320.7mm
310.8mm	920.4mm	1530.0mm	2139.6mm	2749.2mm	3358.8mm
348.9mm	958.5mm	1568.1mm	2177.7mm	2787.3mm	3396.9mm
387.0mm	996.6mm	1606.2mm	2215.8mm	2825.4mm	3435.0mm
425.1mm	1034.7mm	1644.3mm	2253.9mm	2863.5mm	3473.1mm
463.2mm	1072.8mm	1682.4mm	2292.0mm	2901.6mm	3511.2mm
501.3mm	1110.9mm	1720.5mm	2330.1mm	2939.7mm	3549.3mm
539.4mm	1149.0mm	1758.6mm	2368.2mm	2977.8mm	3587.4mm
577.5mm	1187.1mm	1796.7mm	2406.3mm	3015.9mm	3625.5mm
615.6mm	1225.2mm	1834.8mm	2444.4mm	3054.0mm	3663.6mm

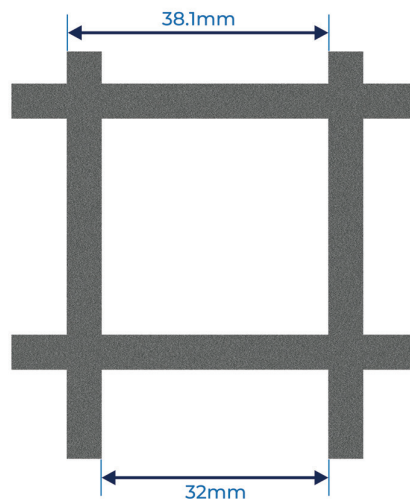

GRP Grating

42mm x 42mm internal, applicable to 50mm grating.

56mm	706mm	1356mm	2006mm	2656mm	3306mm
106mm	756mm	1406mm	2056mm	2706mm	3356mm
156mm	806mm	1456mm	2106mm	2756mm	3406mm
206mm	856mm	1506mm	2156mm	2806mm	3456mm
256mm	906mm	1556mm	2206mm	2856mm	3506mm
306mm	956mm	1606mm	2256mm	2906mm	3556mm
356mm	1006mm	1656mm	2306mm	2956mm	3606mm
406mm	1056mm	1706mm	2356mm	3006mm	3656mm
456mm	1106mm	1756mm	2406mm	3056mm	
506mm	1156mm	1806mm	2456mm	3106mm	
556mm	1206mm	1856mm	2506mm	3156mm	
606mm	1256mm	1906mm	2556mm	3206mm	
656mm	1306mm	1956mm	2606mm	3256mm	

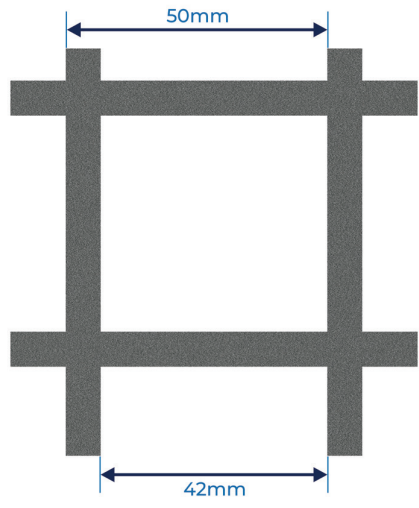

GRP Grating

Load Bearing Specification

Load bearing capacity and panel deflection depend on panel thickness and unsupported span.

Standard Mesh Grating - Load and Deflection (Kg/metre @ 0.5% Deflection)									
Panel Thickness (mm)	Span Type of Loading	250mm	500mm	600mm	750mm	1000mm	1200mm	1500mm	2000mm
25	Point Load	1,792.5kg	232kg	161kg	103kg	58kg	40kg	25.5kg	14.5kg
	UDL	1,375.5kg	688kg	425kg	435kg	92kg	53kg	27kg	11.5kg
38	Point Load	1,907kg	849kg	590kg	378kg	212kg	147kg	94kg	53kg
	UDL	3,815kg	1,907kg	1,590kg	917kg	387kg	224kg	115kg	48.5kg
50	Point Load	2,966kg	1,483kg	1,207kg	773kg	434kg	302kg	193kg	109kg
	UDL	5,933kg	2,967kg	2,472kg	1,877kg	792kg	458kg	235kg	99kg

GRP Grating Accessories

GRP grating clips and clamps complement our range of GRP grating and provide best-practice fixing methods for fastening and joining grating panels.

C Clip - 25mm

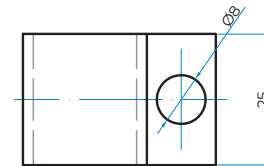
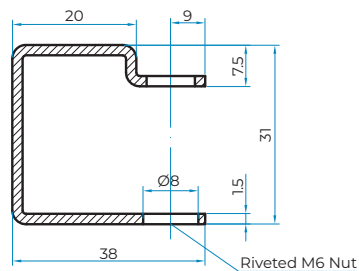

C Clip - 38mm

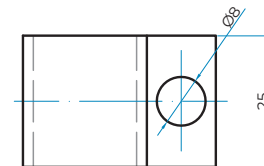
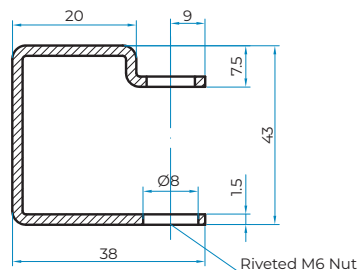



GRP Grating

C Clip - 50mm

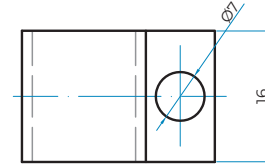
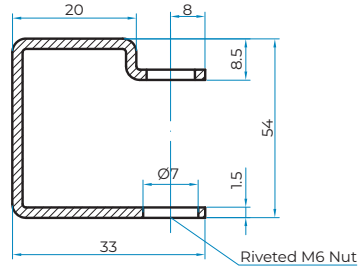

M Clip - 25mm

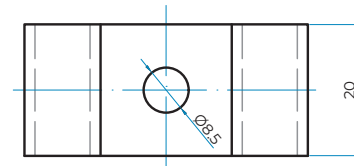
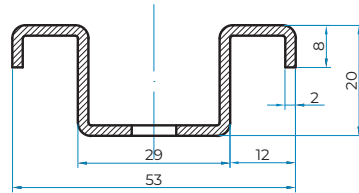

M Clip - 38mm

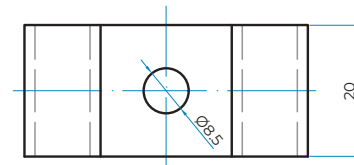
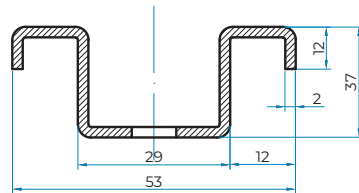

M Clip - 50mm

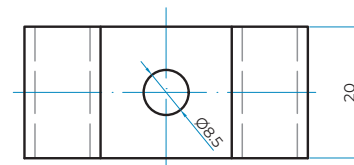
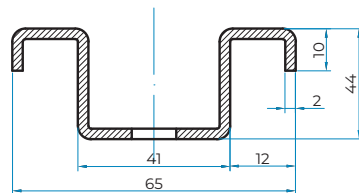



GRP Grating

J Clamp

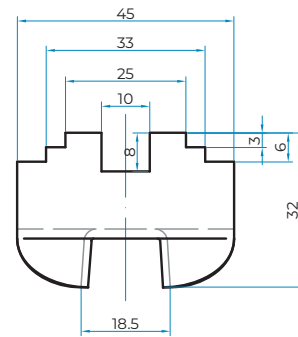
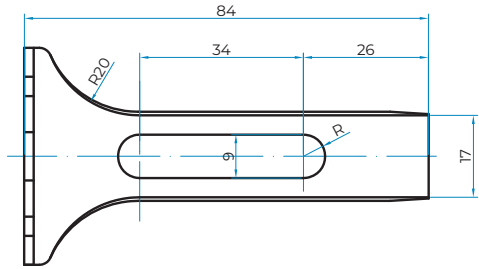
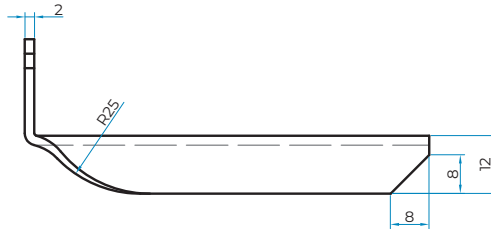

Square Fixing Clip 45mm

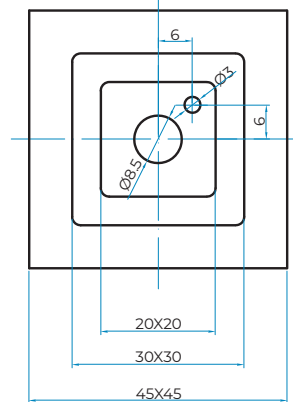
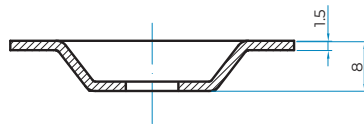

Fixing Disc 45mm

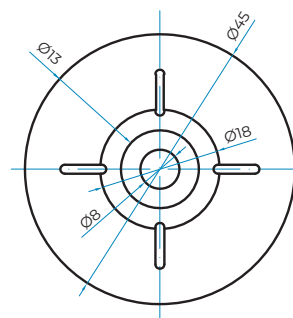
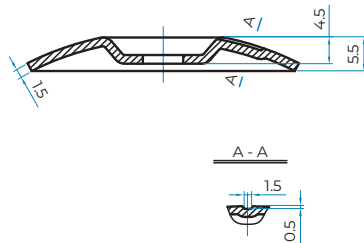



GRP Grating

Installation Diagrams

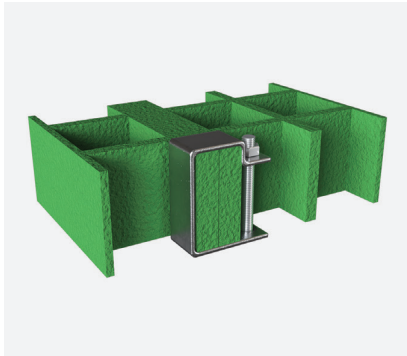

C Clip

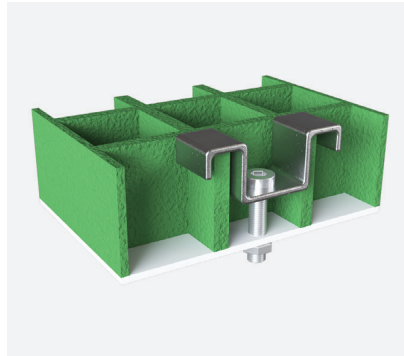

M Clip

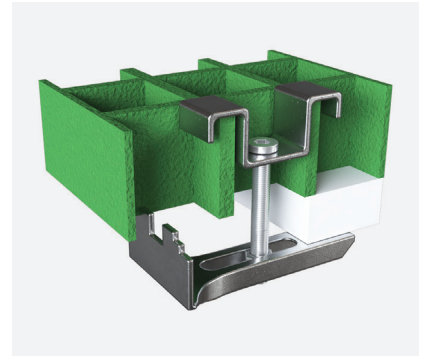

J Clamp

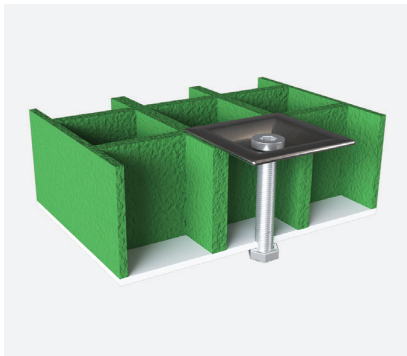

Square Fixing Clip

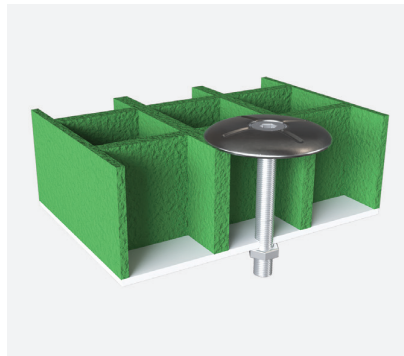

Fixing Disc



GRP Grating

GRP Chemical Resistance Chart

Environment	%Conc.	Max.Oper. Temp.F/C.
Acetic Acid	50	125/52
Aluminum Hydroxide	100	160/71
Ammonium Chloride	ALL	170/77
Ammonium Bicarbonate	15	125/52
Ammonium Hydroxide	28	N/R
Ammonium Sulphate	ALL	170/77
Benzene	ALL	N/R
Benzoic Acid	SAT	150/66
Borax	SAT	170/77
Calcium Carbonate	ALL	170/77
Calcium Nitrate	ALL	180/82
Carbon Tetrachloride	100	N/R
Chlorine Dry Gas	-	140/60
Chlorine Water	SAT	80/27
Chromic Acid	5	70/21
Citric Acid	ALL	170/77
Copper Chloride	ALL	170/77
Copper Cyanide	ALL	170/77
Copper Nitrate	ALL	170/77
Ethanol	50	75/24
Ethylene Glycol	100	90/32
Ferrous Chloride	ALL	170/77
Formaldehyde	50	75/24
Glucose	100	170/77
Gasoline	100	80/27
Glycerine	100	150/66
Hydrobromic Acid	50	120/49
Hydrochloric Acid	37	75/24
Hydrogen Peroxide	5	100/38
Lactic Acid	ALL	170/77

Environment	%Conc.	Max.Oper. Temp.F/C.
Lithium Chloride	SAT	150/66
Magnesium Chloride	ALL	170/77
Magnesium Nitrate	ALL	140/60
Magnesium Sulphate	ALL	170/77
Mercuric Chloride	100	150/66
Mercurous Chloride	ALL	140/60
Nickel Chloride	ALL	170/77
Nickel Sulphate	ALL	170/77
Nitric Acid	20	70/21
Oxalic Acid	ALL	75/24
Perchloric Acid	10	N/R
Phosphoric Acid	100	120/49
Potassium Chloride	ALL	170/77
Potassium Dichromate	ALL	170/77
Potassium Sulphate	ALL	170/77
Propylene Glycol	ALL	170/77
Sodium Acetate	ALL	160/71
Sodium Bisulphate	ALL	170/77
Sodium Bromide	ALL	170/77
Sodium Cyanide	ALL	170/77
Sodium Hydroxide	N/R	N/R
Sodium Nitrate	ALL	170/77
Sodium Sulphate	ALL	170/77
Stannic Chloride	ALL	160/71
Sulfuric Acid	25	75/24
Tartaric Acid	ALL	170/77
Vinegar	100	170/77
Water Distilled	100	170/77
Zinc Nitrate	ALL	170/77
Zinc Sulphate	ALL	170/77